



CROCHET PATTERN

# Ifach

## Sweater

Design: Miss Beetle | Hobbii Design

## MATERIALS

2 (2) 2 (3) skeins of Fluffy Day colour 02  
1 (1) 1 (1) skeins of Fluffy Day colour 06  
2 (2) 2 (3) skeins of Fluffy Day colour 26

Crochet hook 5 mm (US H/8)

Yarn needle

Scissors

## YARN QUALITY

 **Fluffy Day**, Hobbii

100 % Acrylic

100 g (3.8 oz) = 285 m (312 yds)

## GAUGE

10 cm x 10 cm (4" x 4") = 15 sts x 15 rows

## ABBREVIATIONS

ch = ch

hdc slst = half double crochet slip stitch

hdc slst blo = half double crochet slip stitch  
in the back loop only

slst = slip stitch

slst blo = slip stitch in the back loop only

sc = single crochet

## SIZE

S (M) L (XL)

## MEASUREMENTS

**Bust:** 84 (94) 104 (116) cm / 33" (37") 40.9" (45.7")

**Width:** 50.6 (56) 61.4 (66.3) cm / 20" (22") 24.1"  
(26.2")

**Length:** 53.3 (54.6) 57.3 (58.6) cm / 21" (21.5")  
22.5" (23")

## PATTERN INFORMATION

The Ifach sweater is the garment you will wear when you want to feel both warm and stylish. It is built by crocheting 2 body parts and 2 sleeves, joining them and adding the neck ribbing. The design is inspired by the view of the Ifach rock in Calpe from a pebble beach and its colours.

## HASHTAGS FOR SOCIAL MEDIA

#hobbiidesign #hobbiifach #hobbiielements

## QUESTIONS

If you have any questions regarding this pattern, please feel free to email us at [support@hobbii.com](mailto:support@hobbii.com)

Please make sure to include the pattern's name and number.

Happy Crafting!

# Pattern



## INFO AND TIPS

The Ifach sweater consists of three different panels: front piece, back piece and two sleeves. Once crocheted, the panels are joined together. Finally, ribbing is added around the neckline to create the neck.

The body (front piece and back piece) is mostly crocheted with half double crochet slip stitch on the back loop only. The panels include a ribbing that is worked alternating half double crochet slip stitch in the back loop and slip stitch in the back loop in odd and even rows, depending on if you are working on the front or back panel.

The sleeves are mostly crocheted with half double crochet slip stitch on the back loop only. They include a ribbing that is mainly worked with slip stitch in the back loop.

The neck ribbing is worked with slip stitch mainly on the back loop.

How to do the stitches:

- **Slip stitch:** insert the hook in the stitch, yarn over, pull up a loop and directly pull through the loop on the hook.
  - If the pattern says slst **blo**, it means that this stitch has to be done inserting the hook only in the **back** loop.
- **Half double crochet slip stitch:** yarn over, insert the hook in the stitch, yarn over, pull up a loop and directly pull through two loops on the hook.
  - If the pattern says hdc slst **blo**, it means that this stitch has to be done inserting the hook only in the **back** loop.
- **Single crochet:** insert the hook in the stitch, yarn over and pull up a loop. Yarn over and pull through two loops on the hook.

## Colourwork

The sweater is crocheted using the intarsia technique with three colours:

- Colour A: Fluffy Day 02, Ecrú
- Colour B: Fluffy Day 26, Seafoam
- Colour C: Fluffy Day 06, Prussian Blue

Colour graphs are included at the end of the pattern for each size. These graphs represent the intarsia colorwork that needs to be done in each size for both the front and back pieces.

The intarsia in the sleeves is simpler, so a colour graph is not necessary. Instead, in the pattern, the letter which indicates the colour you have to use will appear right before the number of stitches to be done in that colour. Here is an example:

*Row 1: **Colour B** 1 slst in the second ch from the hook, 7 slst, 20 (20) 18 (14) hdc slst. **Colour A** 38 hdc slst. Ch 1 and turn.*

In the row shown, you have to work 8 slst in colour B (these belong to the ribbing). Without changing the colour, work 20 (20) 18 (14) hdc slst. Then, work 38 hdc slst in colour A.

### How to change colour:

You will always change colours in hdc slst (never in slst).

When working in the last hdc slst of one colour, do not complete it with that colour (we will change the colour in the middle of the stitch) and do one more yarn over at the beginning (this will allow us to leave the yarn at the front when we drop it). That is:

- Hdc slst blo to change colours: yarn over, yarn over again (three loops in the hook), insert your hook in the back loop, pull up a loop from the new colour and directly pull through three loops in the hook.



Sometimes, you will need to change colours at the point where you have dropped the yarn in the previous row. However, some other times, you will face these situations:

- You need to change colours before reaching the point where the yarn was dropped in the previous row. In this case, work normally: pull up a loop from the new colour and make sure the strand of yarn from where it was dropped to the new stitch is not very tight. Then, crochet over this strand to hide it.



- You need to change colours after reaching the point where the yarn was dropped in the previous row. In this case, when you meet the new colour strand, carry it and crochet over it (so that you hide it) until you reach the hdc slst where you need to change the colour. Then, work normally.



The design is inspired by the Peñón de Ifach, a beautiful natural park in the coastline in Calpe, a mediterranean city. The intarsia colorwork in the sweater reminds of the view of the Ifach rock and the sea from a pebble beach at its foot.

## GAUGE SWATCH

The gauge is 10 cm x 10 cm (4" x 4") = 15 sts x 15 rows.



To test your gauge, crochet a swatch of 20 stitches x 20 rows.

Ch 21

Row 1: 1 hdc slst in the second ch, 19 hdc slst. Ch 1 and turn.

Row 2: 19 hdc slst blo, 1 hdc slst. Ch 1 and turn.

Repeat row 2 until row 20. Fasten off.

Measure a 10 cm / 4" square in the centre of the swatch. You should have 15 sts x 15 rows.

## MEASUREMENTS

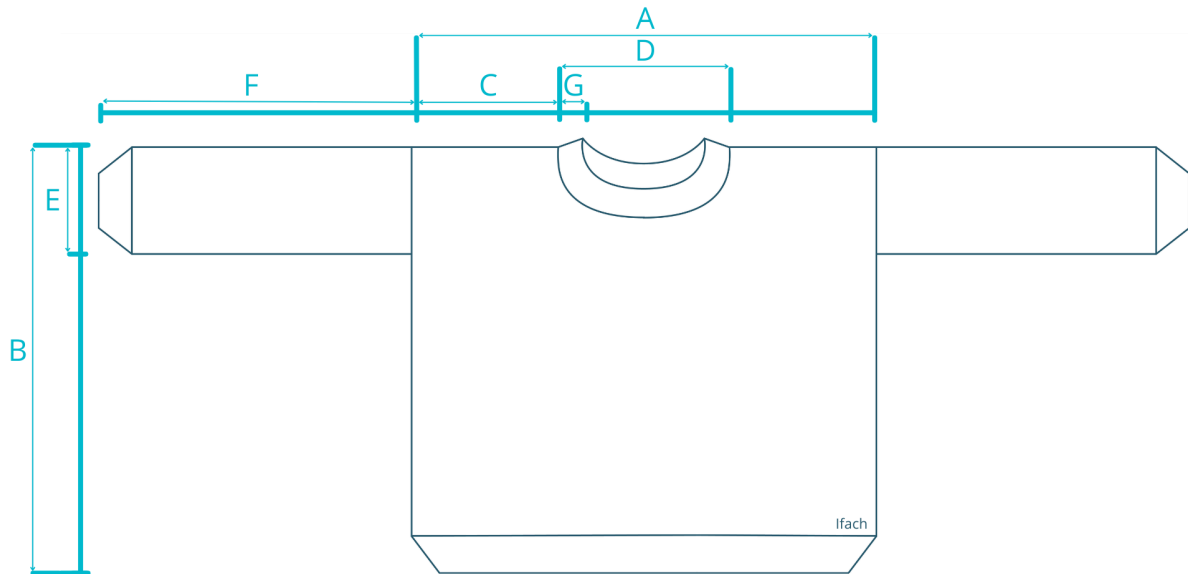

		S	M	L	XL
<b>A</b>	Width	<b>50.6 cm</b> <b>20"</b>	<b>56 cm</b> <b>22"</b>	<b>61.3 cm</b> <b>24.1"</b>	<b>66.6 cm</b> <b>26.2"</b>
<b>B</b>	Length	<b>53.3 cm</b> <b>21"</b>	<b>54.6 cm</b> <b>21.5"</b>	<b>57.3cm</b> <b>22.5"</b>	<b>58.6 cm</b> <b>23"</b>
<b>C</b>	Shoulder width	<b>16 cm</b> <b>6.3"</b>	<b>18.6 cm</b> <b>7.3"</b>	<b>20 cm</b> <b>7.8"</b>	<b>22.6 cm</b> <b>8.9"</b>
<b>D</b>	Neckline width*	<b>18.6 cm</b> <b>7.3"</b>	<b>18.6 cm</b> <b>7.3"</b>	<b>21.3 cm</b> <b>8.3"</b>	<b>21.3 cm</b> <b>8.3"</b>
<b>E</b>	Armhole depth / Sleeve width	<b>15.3 cm</b> <b>6"</b>	<b>16 cm</b> <b>6.3"</b>	<b>17.3 cm</b> <b>6.8"</b>	<b>18.6 cm</b> <b>7.3"</b>
<b>F</b>	Sleeve length	<b>44 cm</b> <b>17.3"</b>	<b>44 cm</b> <b>17.3"</b>	<b>42.6 cm</b> <b>17.7"</b>	<b>40 cm</b> <b>15.7"</b>
<b>G</b>	Neckline ribbing	<b>9 cm</b> <b>3.5"</b>			

\*Without neck ribbing

## FRONT PIECE

Crochet back and forth. This piece includes 3 sections: right shoulder, neckline shaping and left shoulder. Follow the colour graph that corresponds to your size to see what colours to use in each row.



### Right shoulder (when wearing the sweater)

Ch 81 (83) 87 (89)

Row 1: 1 slst in the second ch from the hook, 9 slst, 70 (72) 76 (78) hdc slst. Ch 1 and turn.

Row 2: 79 (81) 85 (87) hdc slst blo, 1 hdc slst. Ch 1 and turn.

Row 3: 10 slst blo, 69 (71) 75 (77) hdc slst blo, 1 hdc slst. Ch 1 and turn.

Repeat rows 2 and 3 until row 24 (28) 30 (34). *Note that you will finish with an even row, so you will have to work it as row 2.*

### Neck shaping

Row 25 (29) 31 (35): 10 slst blo, 64 (66) 70 (72) hdc slst blo. Ch 1 and turn. *Note that 6 stitches are left unworked.*

Row 26 (30) 32 (36): 73 (75) 79 (81) hdc slst blo, 1 hdc slst. Ch 1 and turn.

Row 27 (31) 33 (37): 10 slst blo, 62 (64) 68 (70) hdc slst blo. Ch 1 and turn. *Note that 2 stitches are left unworked.*

Row 28 (32) 34 (38): 71 (73) 77 (79) hdc slst blo, 1 hdc slst. Ch 1 and turn.

Row 29 (33) 35 (39): 10 slst blo, 60 (62) 66 (68) hdc slst blo. Ch 1 and turn. *Note that 2 stitches are left unworked.*

Row 30 (34) 36 (40): 69 (71) 75 (77) hdc slst blo, 1 hdc slst. Ch 1 and turn.

Row 31 (35) 37 (41): 10 slst blo, 58 (60) 64 (66) hdc slst blo. Ch 1 and turn. *Note that 2 stitches are left unworked.*

Row 32 (36) 38 (42): 67 (69) 73 (75) hdc slst blo, 1 hdc slst. Ch 1 and turn.

Row 33 (37) 39 (43): 10 slst blo, 58 (60) 64 (66) hdc slst blo. Ch 1 and turn.

Repeat rows 32 (36) 38 (42) and 33 (37) 39 (43) until row 46 (50) 56 (60).

Row 47 (51) 57 (61): 10 slst blo, 58 (60) 64 (66) hdc slst blo. **Ch 3** and turn.

Row 48 (52) 58 (62): 1 hdc slst in the second ch from the hook, 1 hdc slst, 67 (69) 73 (75) hdc slst blo, 1 hdc slst. Ch 1 and turn.

Row 49 (53) 59 (63): 10 slst blo, 60 (62) 66 (68) hdc slst blo. **Ch 3** and turn.

Row 50 (54) 60 (64): 1 hdc slst in the second ch from the hook, 1 hdc slst, 69 (71) 75 (77) hdc slst blo, 1 hdc slst. Ch 1 and turn.

Row 51 (55) 61 (65): 10 slst blo, 62 (64) 68 (70) hdc slst blo. **Ch 3** and turn.

Row 52 (56) 62 (66): 1 hdc slst in the second ch from the hook, 1 hdc slst, 71 (73) 77 (79) hdc slst blo, 1 hdc slst. Ch 1 and turn.

### Left shoulder

Row 53 (57) 63 (67): 10 slst blo, 64 (66) 70 (72) hdc slst blo. **Ch 7** and turn.

Row 54 (58) 64 (68): 1 hdc slst in the second ch from the hook, 5 hdc slst, 73 (75) 79 (81) hdc slst blo, 1 hdc slst. Ch 1 and turn.

Row 55 (59) 65 (69): 10 slst blo, 69 (71) 75 (77) hdc slst blo, 1 hdc slst. Ch 1 and turn.

Row 56 (60) 66 (70): 79 (81) 85 (87) hdc slst blo, 1 hdc slst. Ch 1 and turn.

Repeat rows 55 (59) 65 (69) and 56 (60) 66 (70) until row 76 (84) 92 (100). Do not ch 1 at the end of the last row. Fasten off.

## BACK PIECE

Crochet back and forth. This piece includes 3 sections: left shoulder, neckline shaping and right shoulder. Follow the colour graph that corresponds to your size to see what colours to use in each row.





### Left shoulder (when wearing the sweater)

Ch 81 (83) 87 (89).

Row 1: 1 slst in the second ch from the hook, 9 slst, 70 (72) 76 (78) hdc slst. Ch 1 and turn.

Row 2: 79 (81) 85 (87) hdc slst blo, 1 hdc slst. Ch 1 and turn.

Row 3: 10 slst blo, 69 (71) 75 (77) hdc slst blo, 1 hdc slst. Ch 1 and turn.

Repeat rows 2 and 3 until row 24 (28) 30 (34). *Note that you will finish with an even row, so you will have to work it as row 2.*

### Neck shaping

Row 25 (29) 31 (35): 10 slst blo, 68 (70) 74 (76) hdc slst blo. Ch 1 and turn. *Note that 2 stitches are left unworked.*

Row 26 (30) 32 (36): 77 (79) 83 (85) hdc slst blo, 1 hdc slst. Ch 1 and turn.

Row 27 (31) 33 (37): 10 slst blo, 68 (70) 74 (76) hdc slst blo. Ch 1 and turn.

Repeat rows 26 (30) 32 (36) and 27 (31) 33 (37) until row 52 (56) 62 (66).

### Right shoulder

Row 53 (57) 63 (67): 10 slst blo, 68 (70) 74 (76) hdc slst blo. **Ch 3** and turn.

Row 54 (58) 64 (68): 1 hdc slst in the second ch, 1 hdc slst, 77 (79) 83 (85) hdc slst blo, 1 hdc slst. Ch 1 and turn.

Row 55 (59) 65 (69): 10 slst blo, 69 (71) 75 (77) hdc slst blo, 1 hdc slst. Ch 1 and turn.

Row 56 (60) 66 (70): 79 (81) 85 (87) hdc slst blo, 1 hdc slst. Ch 1 and turn.

Repeat rows 55 (59) 65 (69) and 56 (60) 66 (70) until row 76 (84) 92 (100). Do not ch 1 at the end of the last row. Fasten off.

## RIGHT SLEEVE

Crochet back and forth.

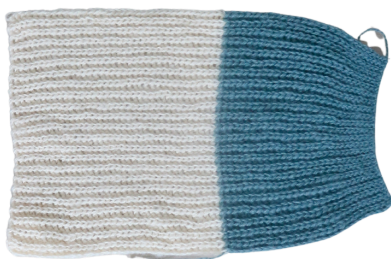

Ch 38 in **colour A**. Then, change to **colour B** and ch 29 (29) 27 (23).

Row 1: **Colour B** 1 slst in the second ch from the hook, 7 slst, 20 (20) 18 (14) hdc slst. **Colour A** 38 hdc slst. Ch 1 and turn.

Row 2: **Colour A** 38 hdc slst blo. **Colour B** 20 (20) 18 (14) hdc slst blo, 7 slst blo, 1 slst.

Row 3: **Colour B** 8 slst blo, 20 (20) 18 (14) hdc slst blo. **Colour A**: 37 hdc slst blo, 1 hdc slst blo. Ch 1 and turn.

Repeat rows 2 and 3 until row 46 (48) 52 (56). Do not ch 1 at the end of the last row. Fasten off.

## LEFT SLEEVE

Crochet back and forth.

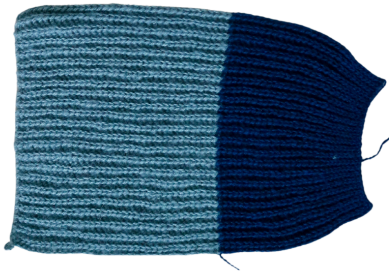

Ch 38 in colour B. Then, change to colour C and ch 29 (29) 27 (23)

Row 1: **Colour C** 1 slst in the second ch from the hook, 7 slst, 20 (20) 18 (14) hdc slst. **Colour B** 38 hdc slst. Ch 1 and turn.

Row 2: **Colour B** 38 hdc slst blo. **Colour C** 20 (20) 18 (14) hdc slst blo, 7 slst blo, 1 slst.

Row 3: **Colour C** 8 slst blo, 20 (20) 18 (14) hdc slst blo. **Colour B**: 37 hdc slst blo, 1 hdc slst blo. Ch 1 and turn.

Repeat rows 2 and 3 until row 46 (48) 52 (56). Do not ch 1 at the end of the last row. Fasten off.

## ASSEMBLING

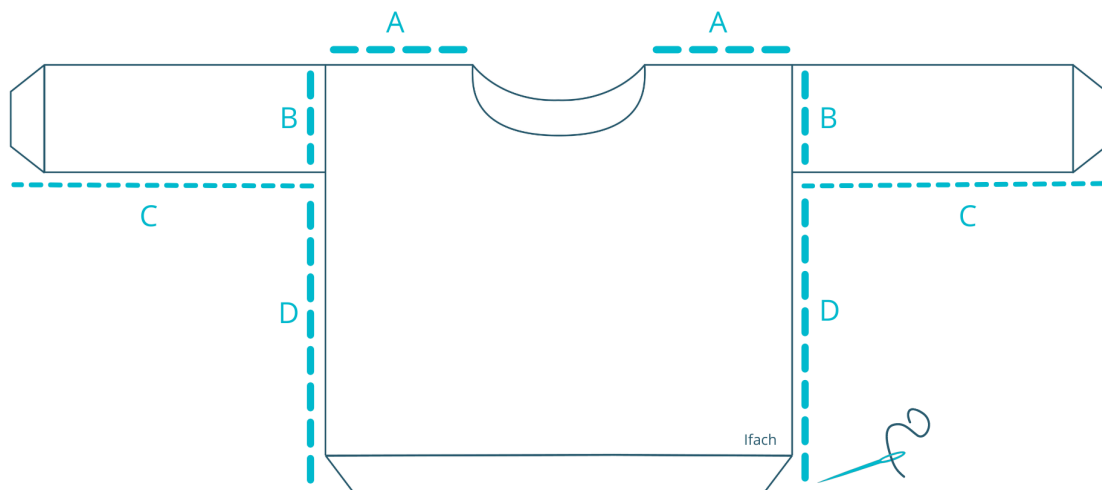

Use a yarn needle and sew using an invisible stitch.

Join the front and back panels on shoulders (A). Then, fold each sleeve and join them to both sides (B), leaving the open part downwards. Sew the open side of the sleeve (C). Finally, join the back and front panels on sides (D).

## NECK RIBBING



Join the yarn on one side of the neckline. Sc evenly around the neckline until you get back to the first st. Try to do 1 sc per row and 1 sc per st in the neckline. Slst in the first st.

Ch 17

Row 1: 1 slst in the second ch. 15 slst. Join with 2 slst in the next 2 sts of the hem.

Row 2: 15 slst blo, 1 slst. Ch 1 and turn.

Row 3: 16 sl st blo. Join with 2 sl st in the next 2 sts of the hem.

Repeat rows 2 and 3 until you complete all sts around the neckline. Fasten off, leaving a long strand to sew.

Join the end of the neck to the start. Fasten off.



The neck of the sweater is designed to have a wide turtleneck style (as shown in the first picture). However, if you prefer the neck ribbing to be thinner (as shown in the second picture) you can fold the ribbing inwards and sew the edge to the neckline- where the body panels end and the neck starts.

## COLOUR GRAPH

### Size S: front piece

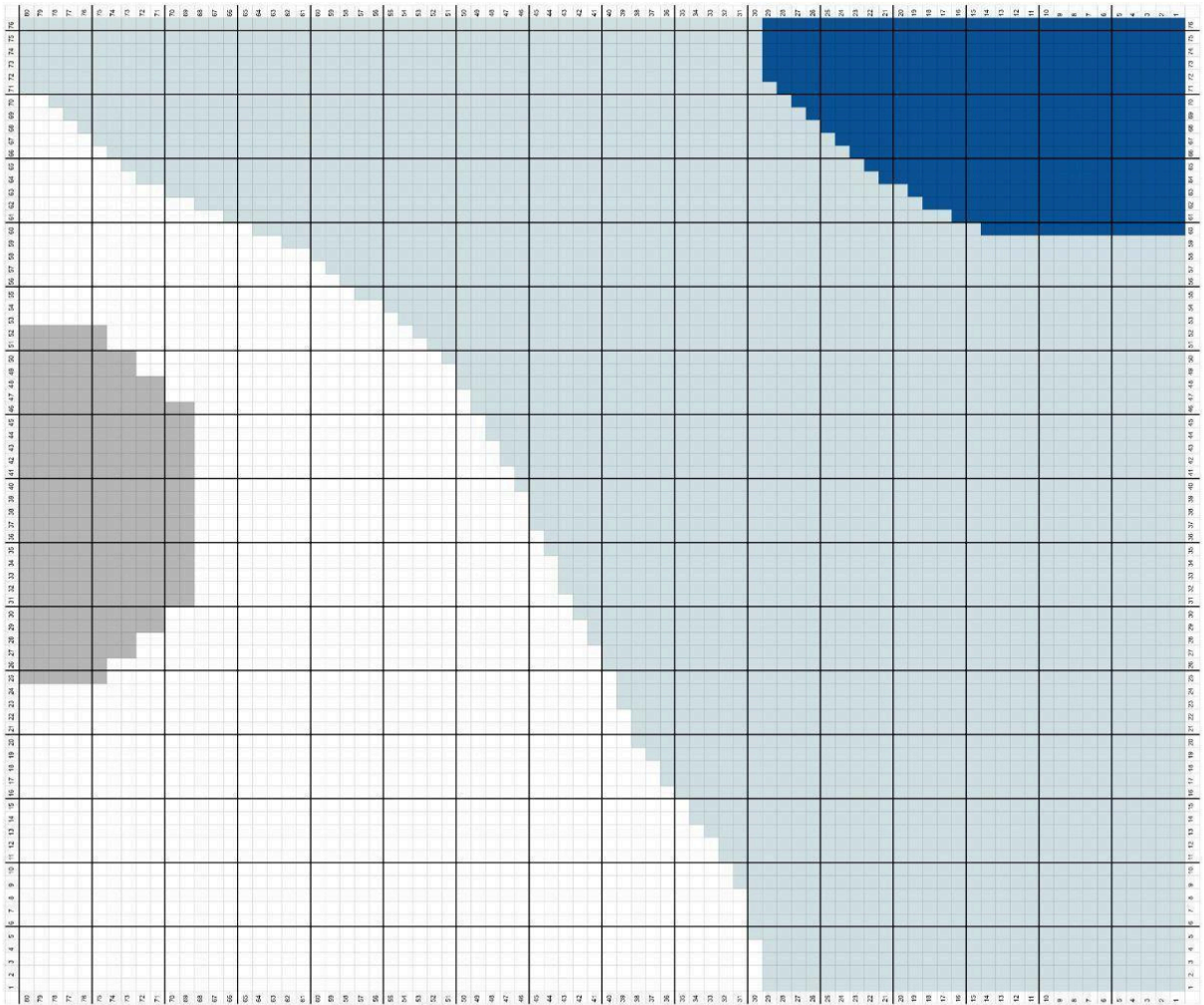

Size S: Back piece

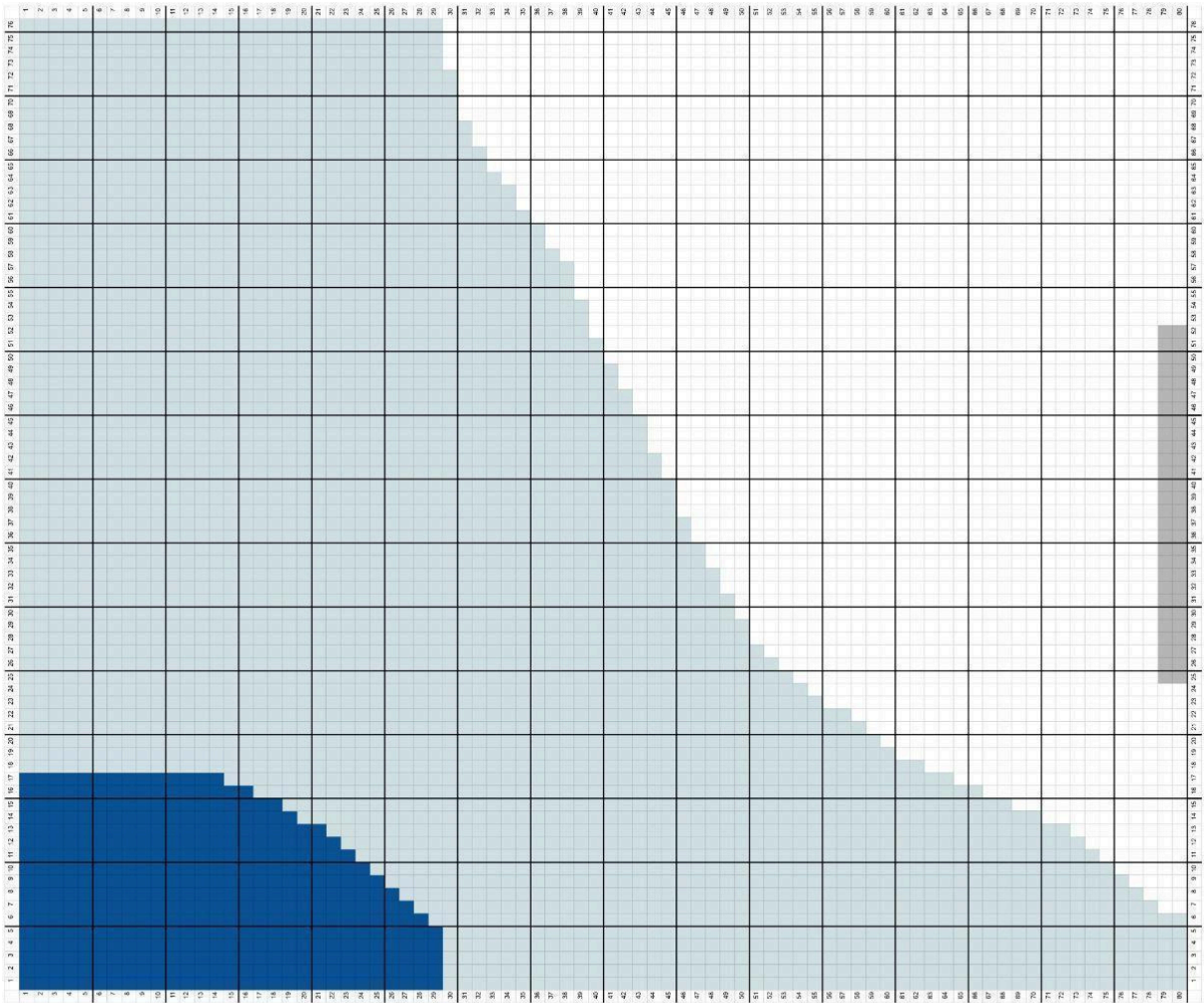

Size M: front piece

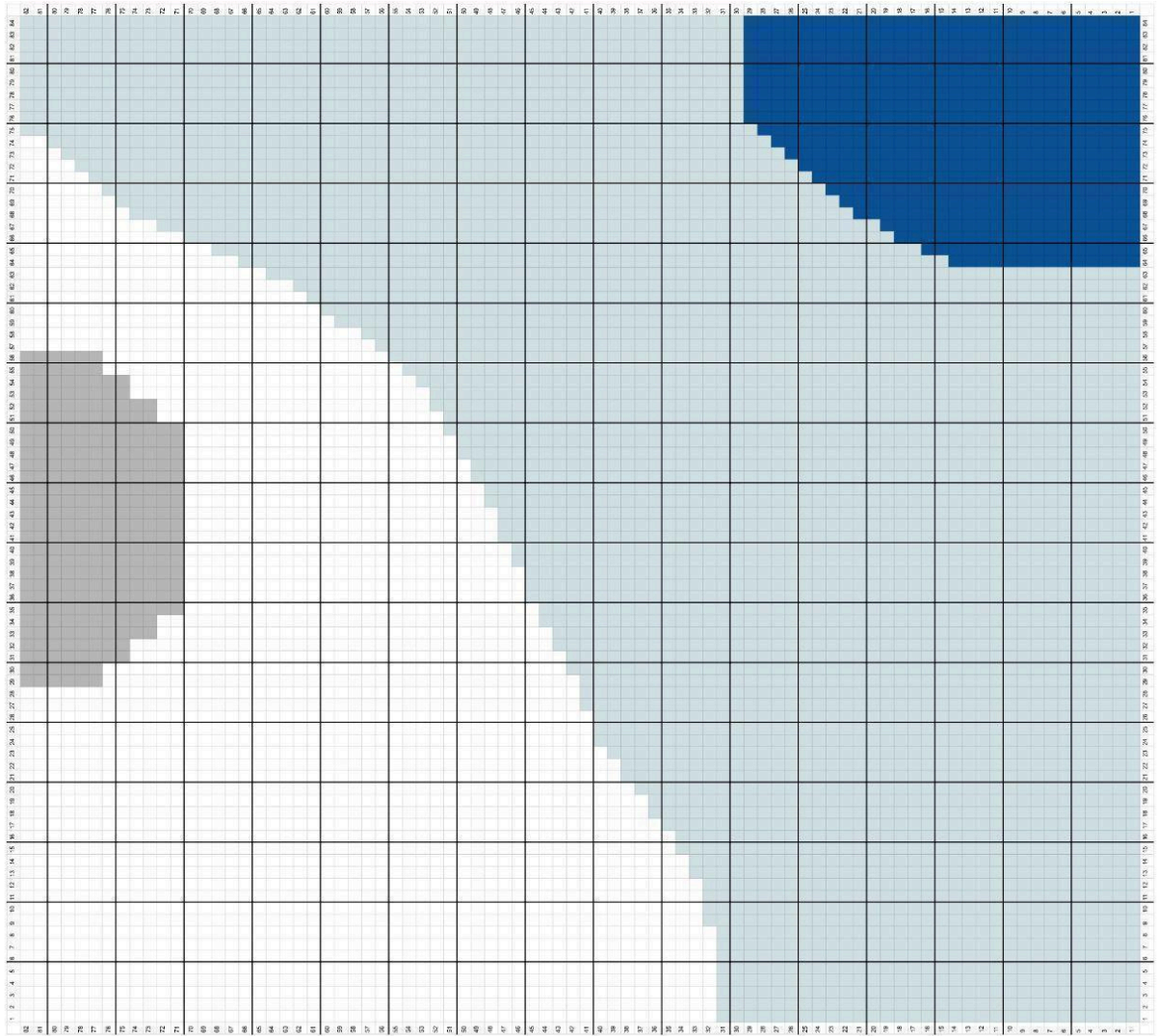

Size M: Back piece

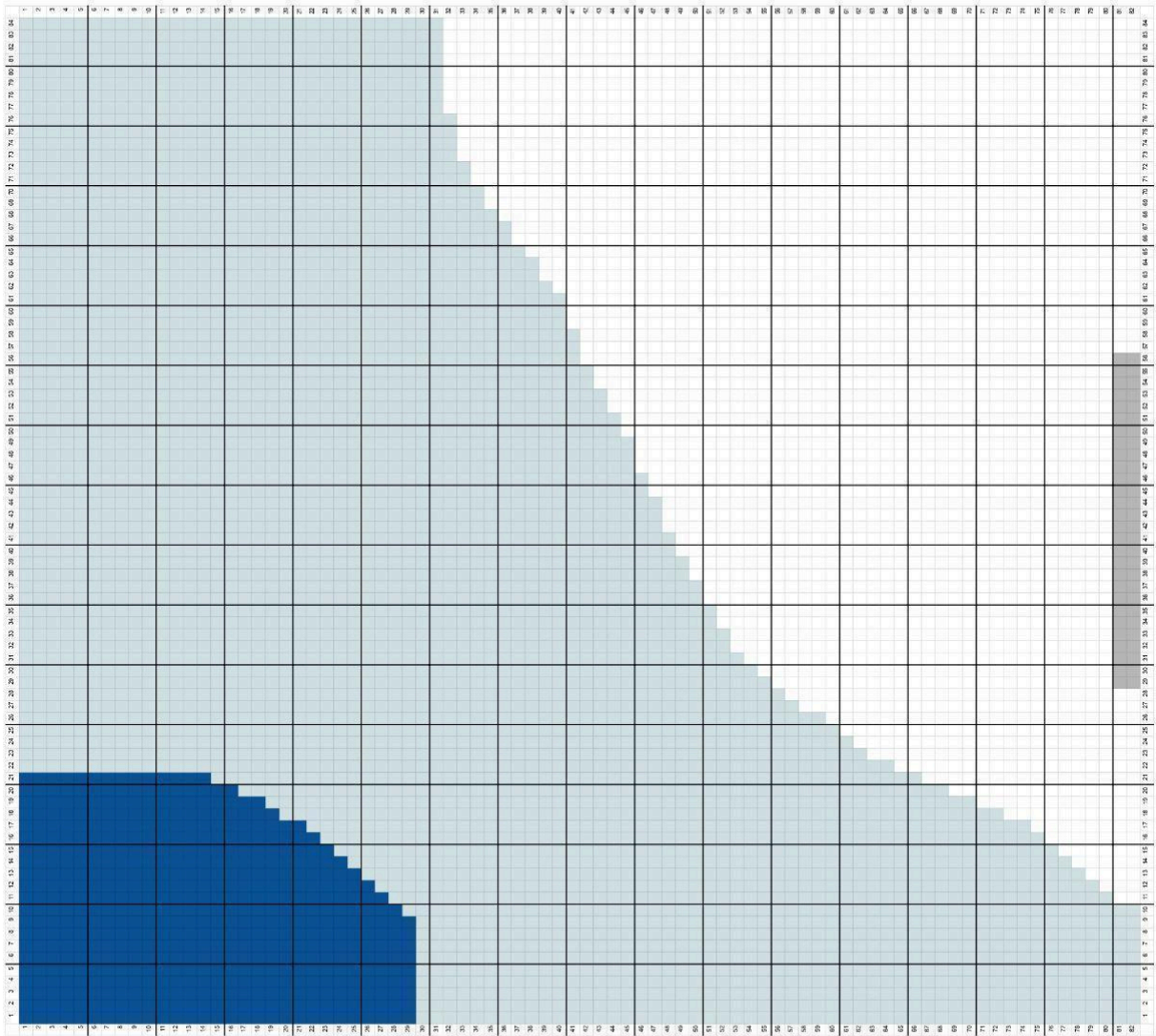



Size L: front piece

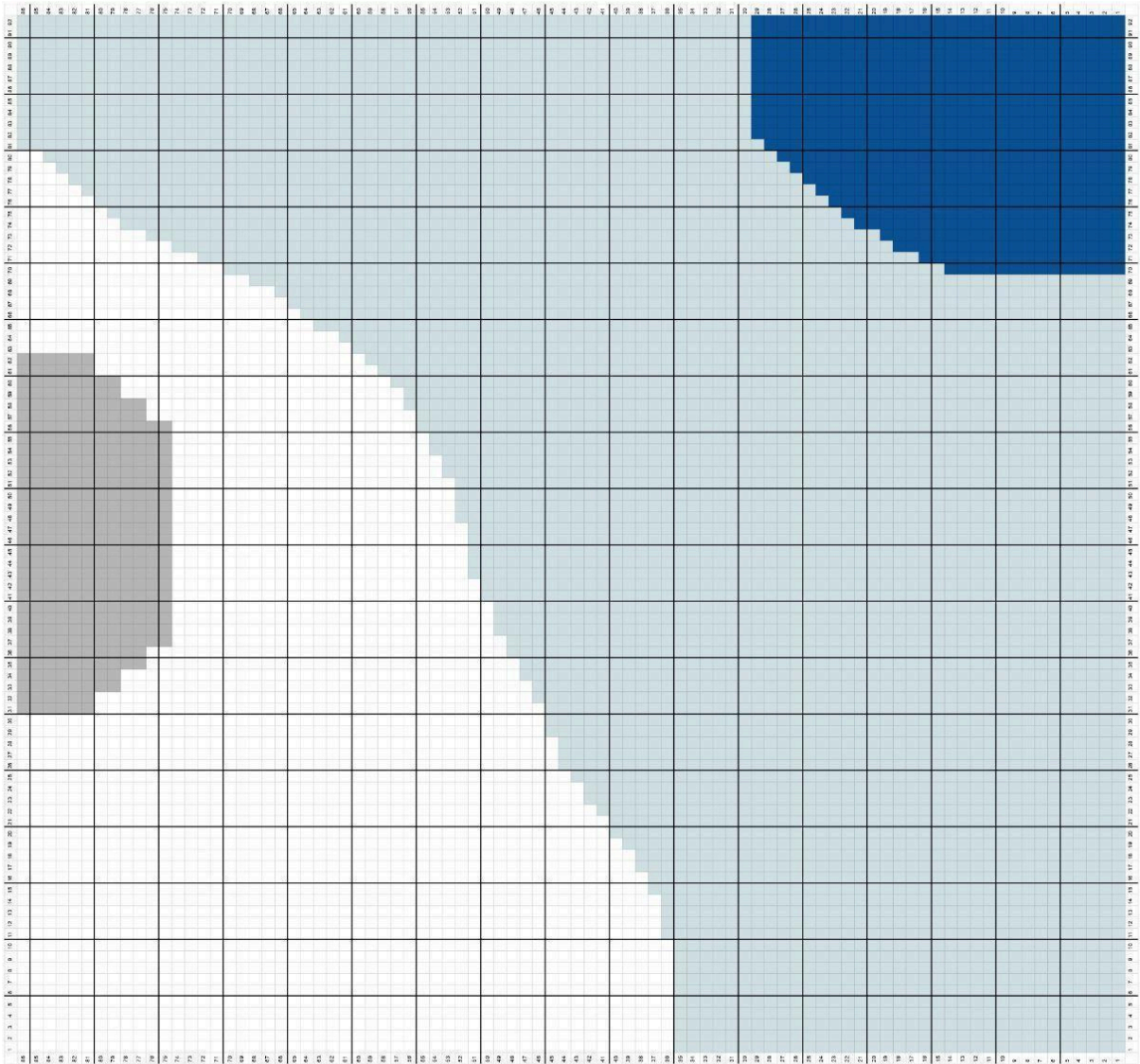

Size L: Back piece

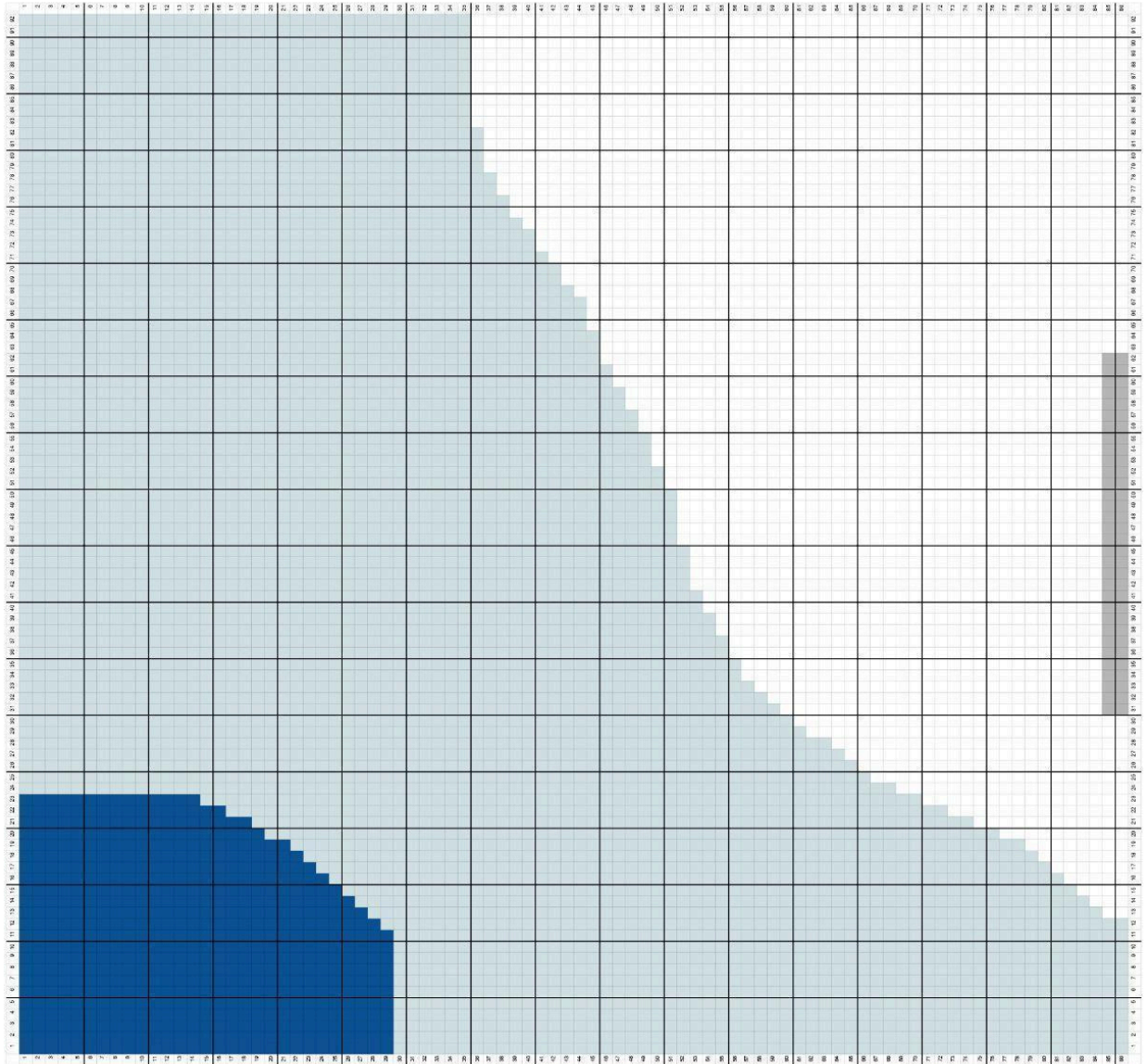

Size XL: front piece

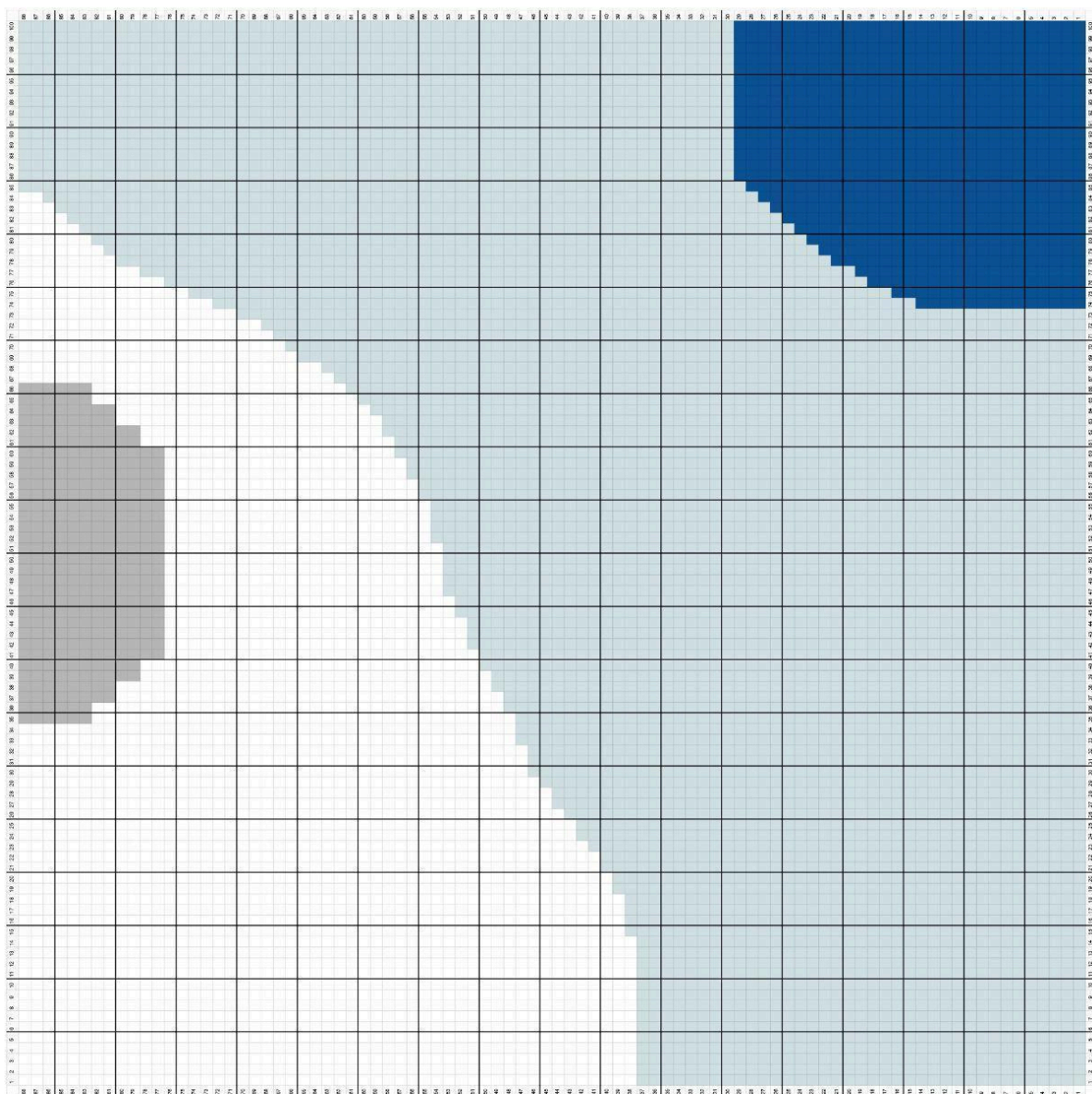

### Size XL: Back piece

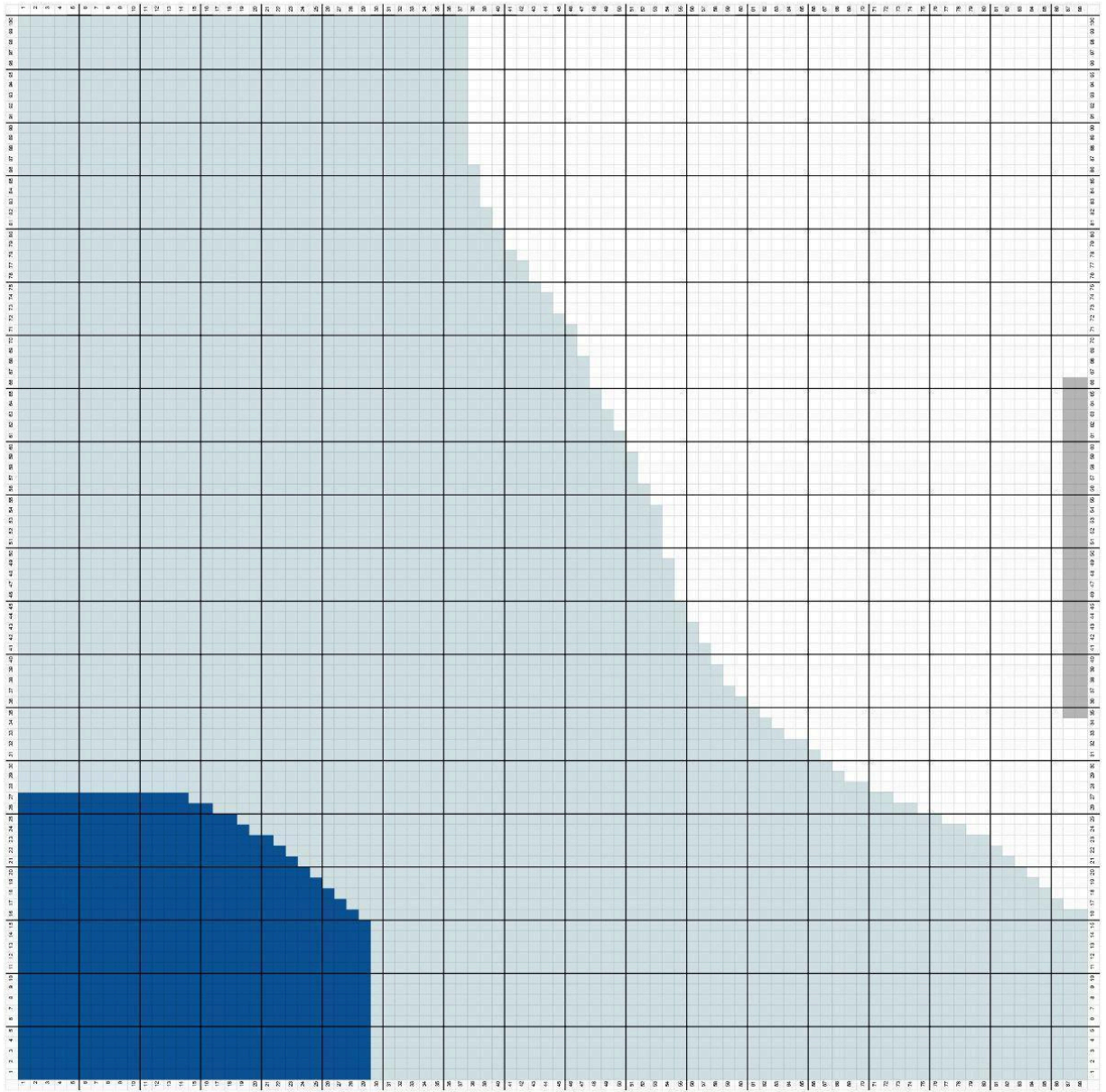

Enjoy!

Beatriz Cánovas · Miss Beetle

